

KEYSTONE

K-LOK® Series 36 – ASME 150

K-LOK® Series 37 – ASME 300

Features and Benefits

- K-LOK® polymer and elastomer seats provide bi-directional, drop-tight closure in vacuum as well as at full rated differential pressure. Its unique design does not rely on pressure to assist sealing therefore seals at high and low pressures, as well as dirty services. A variety of materials allows optimum seat life in all applications.
- Blow-out resistant shaft is standard on all valves for increased safety.
- Unique packing design allows for use in pressure as well as vacuum without modification or special assembly.
- Disc taper pins are tangentially positioned half in disc and half in stem, placing them in compression rather than shear, which eliminates potential for failure.
- Rocker-shaped gland bridge compensates for uneven adjustment of gland nuts reducing packing leaks.
- Integrally cast disc position stop perfectly locates the disc in seat, achieving maximum seat and seal life.
- Extended neck allows for two inches of pipeline insulation.
- Integrally cast mounting pad provides direct mounting of actuators eliminating the need for costly brackets and couplings.
- Flattened body bore at stem journal ports positions stem bearings near disc, providing maximum stem support.

General Applications

- Modulating service
- Airport refueling
- Hydrocarbon processing
- Chemical/petrochemical processing
- Purified gas
- Steam and vacuum services
- Power and utilities
- Refrigeration
- HVAC



Technical Data

Size range: 2" to 36"

Vacuum rating: 4 x 10⁻⁵ in Hg

Pressure rating: Series 36 – ASME 150

Series 37 – ASME 300

Temperature rating: -40°F to 1000°F

Full compliance to API 609 Standard.

Metal seated and fire-safe valves are available. For more information on these trims see Figures 360/362 data sheet (KEYMC-0032).

Lug body is full rated for bi-directional dead end service as a standard.

Principles of Operation

Double Offset Disc/stem

K-LOK®'s unique two-piece stem and double-offset disc/stem design allows for high cycling and creates a lower disc profile with increased capacity and a range of 33:1.

In addition to increasing the flow area across the disc, this design minimizes wear points between seat and disc.

The first offset is achieved by locating the stems downstream of the center-line of the seat. This allows for a totally unobstructed 360° sealing surface.

The second offset locates the stems off-center of the vertical axis of the seat.

The combination of these two offsets creates a camming effect as the disc swings into and out of the seat. The disc lifts quickly out of the seat in the first few degrees of travel and does not contact the seat again until it is nearly closed. There are no wear points between the seat and disc, while operating torques are reduced and seat life is extended.

Double Offset

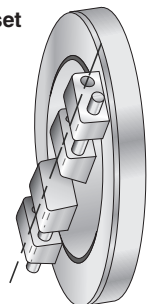

First Offset

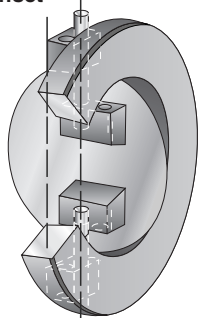

Second Offset

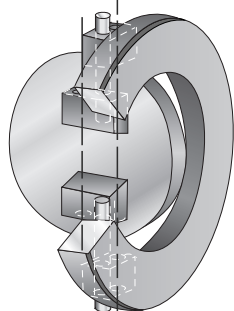

Adjustable Stem Packaging (Polymer Seated Valves)

The K-LOK®'s unique stem packing is composed of 3 rings of braided Teflon® rope between one Teflon® V-ring at the top and bottom. The packing operates on an interference fit with the body and therefore will seal in pressure and vacuum. Many other manufacturers' designs will require special packing for vacuum services.

This packing is easily field adjustable without the need to remove actuation due to its unique inverted packing adjustment bolts. Another important feature is the use of a rocker shaped packing gland bridge that compensates for uneven tightening of the packing gland bolts eliminating packing leaks due to uneven packing compression.

Blow-out Resistant Shaft (BOR)

The Keystone K-LOK® high performance butterfly valve contains a blow-out resistant shaft as a standard. This is achieved by machining a groove in the shaft that allows a snap ring to lock into the stem groove. The packing gland follower is provided with an undercut on its lower surface which encapsulates the locked in snap ring. This design provides positive retention of the shaft in the unlikely event of a shaft breakage.

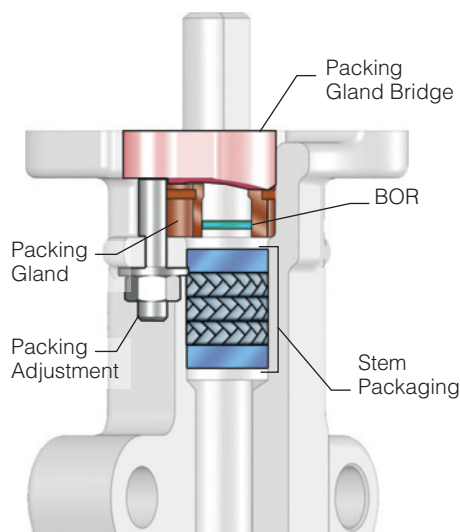

Two-piece Stem vs. One-piece Stem

K-LOK®'s disc geometry maximizes flow capacity by increasing the available flow area through the valve. This increase in disc efficiency results in a higher valve C_v .

Competitor one-piece stem **K-LOK®** two-piece stem

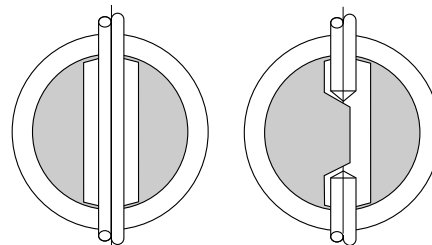

$$\text{Aspect Ratio} = \text{Open Area} \div \text{Disc Area}$$

Standards and Specifications Applicable for K-LOK®

ASME	B16.34	Steel valves
	B31.3	Chemical plant and petroleum refinery piping
	B16.5	Steel pipe flanges and flange fittings
MSS	SP-6	Standard finishes for pipe flanges
	SP-25	Standard marking systems for valves
	SP-55	Quality standard for steel casting
	SP-61	Pressure testing of steel valves
API	609	High pressure offset disc butterfly valves
	607	Butterfly valves (most models)
	598	Fire-test for soft seated quarter-turn valves
NSF/ANSI Standard 61		Valve inspection and test, upon request
		Potable water, upon request
PED/CE		European directive, upon request

Seat Design

The K-LOK® seat is a true interference seat design and unlike most other manufactures does not rely on line pressure to assist in sealing. All seats seal drop-tight bi-directionally at low and high pressure as well as vacuum. Given the interference seat design the K-LOK® will also operate in dirty services where most pressure assist valves fail.

Polymer (PTFE, RTFE and UHMWPE) seats incorporate a unique design consisting of a stainless steel braided wire winding, enclosed in a U-shape envelope to provide seating energy and

memory. This wire winding allows axial flexibility in both directions of flow. The winding also allows radial flexibility when the disc is not fully closed, reducing seat/disc interference, seat wear and stem torque. When the disc closes, it provides circumferential stiffness and assures the required disc/seat seals tight in both vacuum and pressure.

Elastomer seats are molded around a stack of V-shaped steel rings that provide the same stability, support and flexure as the wire windings in polymer seats.

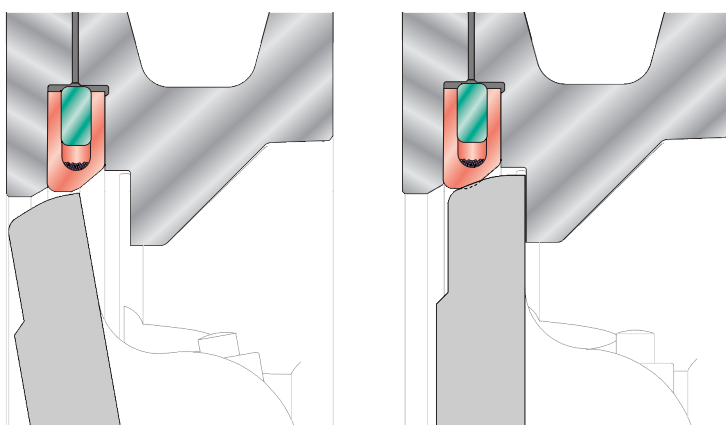

Seat Replacement

All seats for the Keystone K-LOK® are easily field replaceable. Simply remove seat retainer ring, rotate disc to fully closed position and replace seat assembly and gasket. Dis-assembly of the disc and shaft is not required. Seat retaining ring gaskets are not used with elastomer seats.

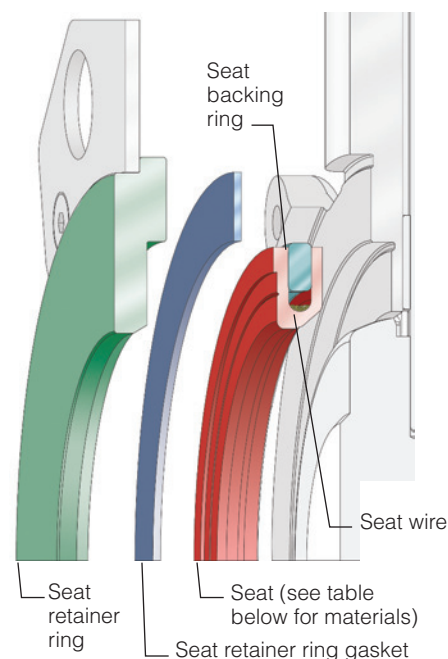

Seat Materials

Seat	Material	Typical Applications
1. PTFE	Polytetrafluoroethylene	Pharmaceuticals, water, jet fuel, river water, air
2. RTFE	Reinforced Polytetrafluoroethylene	Saturated steam, chlorine, ammonia, natural gas vacuum, oxygen, nitrogen
3. UHMWPE	Ultra high molecular weight polyethylene	Abrasives, suspended solids, scaling mediums
For Seats 1 thru 3		
Wire Wrap	Stainless steel braided wire	
Seat Backing Ring	Polyester, phenolic or stainless steel	General purpose services Steam, ammonia

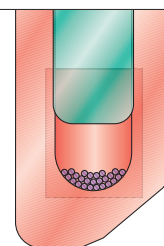

Seat	Material	Typical Applications
4. EPDM	–	Cooling water, chilled water,
5. NBR	–	HVAC, river water intakes,
6. Fluoroelastomer (FKM)	–	abrasives, vacuum

For Seats 4 thru 6

Metal Insert	Carbon steel
--------------	--------------

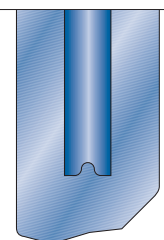

Keystone High Performance Butterfly Valves

Series 36 and 37, 2" to 36"

Seat Tightness

All polymer seated valves are factory tested for bi-directional drop tight shut-off at 10% above the rated pressure. This exceeds the ANSI FCI 70-2 standard which establishes a service of six leakage classes for control valves as per below:

ANSI/FCI 70-2 Control Valve Seat Leakage, Tolerances, and Test Specifications

ANSI B16.104-1976	Maximum Leakage			Test Medium	Pressure and Temperature
Class VI	Nominal Port Diameter (in.)	Bubbles per Minute ³	ml. per Minute	Air or Nitrogen	Service ΔP or 50 psig [3.4 bar differential], whichever is lower, at 50°F to 125°F [10°C to 52°C]
	2	3	0.45		
	2½	4	0.60		
	3	6	0.90		
	4	11	1.70		
	6	27	4.00		
	8	45	6.75		
Class V	5 x 10 ⁻⁴ ml/min/psig/in. port dia. [5 x 10 ⁻¹² m ³ /sec/bar differential/mm port dia.]			Water	Service ΔP at 50°F to 125°F [10°C to 52°C]
Class IV	0.01% valve capacity at full travel			Air or Water	Service ΔP or 50 psig [3.4 bar differential], whichever is lower, at 50°F to 125°F [10°C to 52°C]

Notes:

1. K-LOK® polymer and elastomer seats meet or exceeds ANSI Class VI shut-off.
2. K-LOK® metal seats and fire-safe seats (post fire exposure) meet or exceeds ANSI Class IV shut-off.
3. Using the ANSI/FCI specified calibrated measuring device.

Reference ANSI/FCI 70-2 for further information.

Abrasion Resistant Trims (up to 250°F)

Body	Disc	Shaft	Seat/Backing Ring	Gasket	Packing
Steel	316 SS/ENP	17-4PH SS	UHMWPE/polyester	Non asbestos fiber	PTFE
316 SS	316 SS/ENP	17-4PH SS	UHMWPE/polyester	Non asbestos fiber	PTFE

General Purpose Trims (up to 500°F)

Body	Disc	Shaft	Seat/Backing Ring	Gasket	Packing
Steel	316 SS	17-4PH SS	RTFE/SS	Graphite	PTFE
316 SS	316 SS	17-4PH SS	RTFE/SS	Graphite	PTFE

Steam Trims

Body	Disc	Shaft	Seat/Backing Ring	Gasket	Packing
Steel	316 SS/ENP	17-4PH SS	RTFE/SS	Graphite	Graphite
316 SS	316 SS/ENP	17-4PH SS	RTFE/SS	Graphite	Graphite

Corrosion Resistant Trims

Body	Disc	Shaft	Seat/Backing Ring	Gasket	Packing
316 SS	316 SS	316 SS Cond. B	RTFE/SS	Non asbestos fiber	Graphite
316 SS	316 SS	NITRONIC 50®	RTFE/SS	Non asbestos fiber	Graphite

Note: Other trims are available; please contact your sales representative.

Special Service Valves Available

- Oxygen cleaned valves
- NSF-61 certified valves
- Chlorine cleaned valves
- Seawater valves
- Alloy trimmed valves
- PED/CE certified valves

Please contact your local sales representative for other requests.

Materials of Construction

Wafer Style

Lug Style

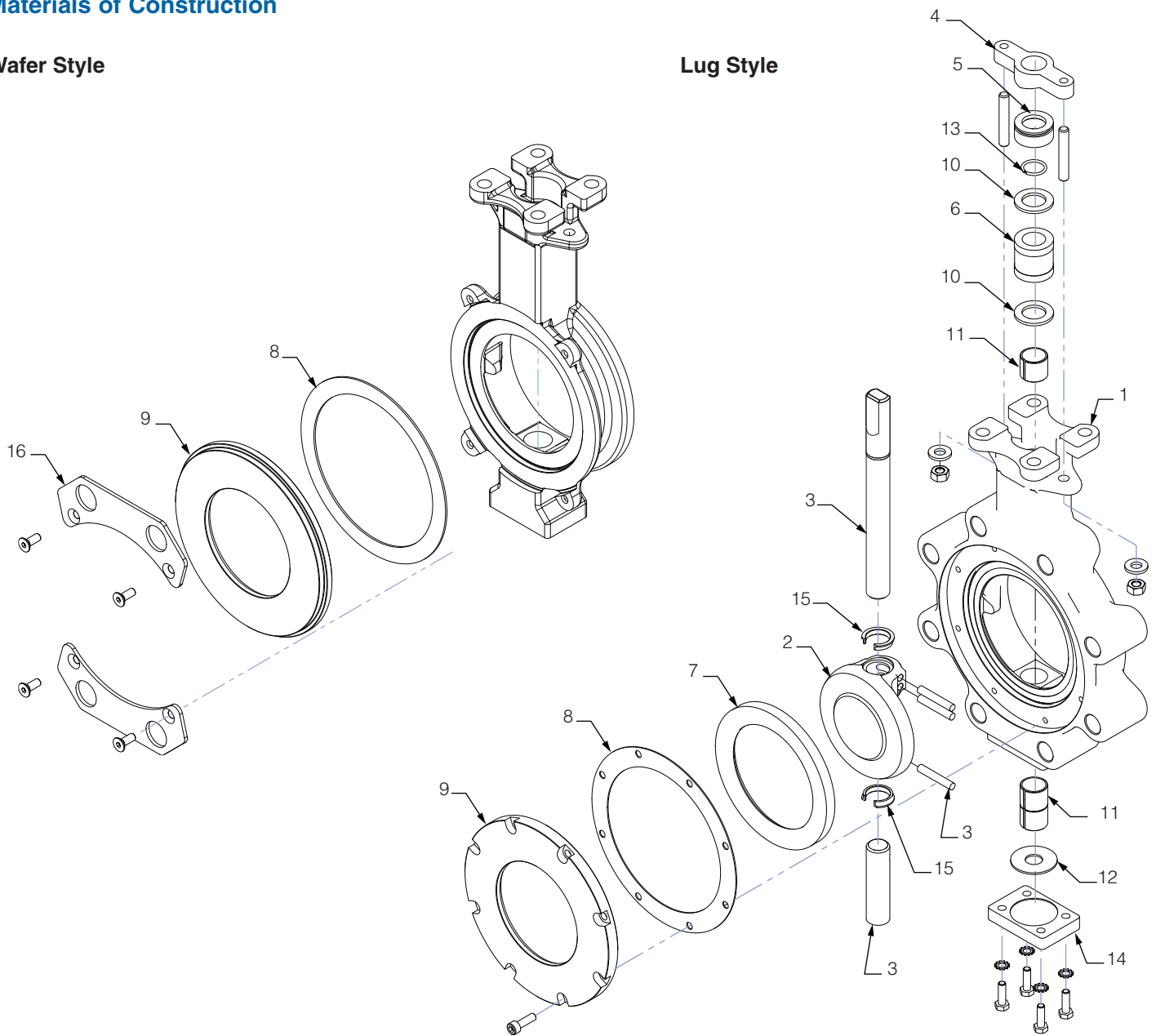

Standard Materials of Construction

No.	Description	Material	Material Standard	No.	Description	Material	Material Standard
1	Body	Carbon steel Stainless steel	ASTM A216-WCB ASTM A351-CF8M	9	Seat retainer ring	Carbon steel 316 SS	ASTM A216-WCB ASTM A351-CF8M
2	Disc	316 SS 316 SS/ENP	ASTM A351-CF8M ASTM A351-CF8M/ electroless nickel plated	10	Anti-extrusion ring	316 SS	-
3	Stem and taper pins	316B SS NITRONIC 50® 17-4 PH SS	ASTM A276-316 Condition B ASTM A276-XM19 ASTM A564 Condition H1075 or H1100	11	Stem bearing	RTFE/Composite 316 SS/Nitride	-
4	Gland bridge	17-4PH SS	-	12	Bottom cover gasket	Non-asbestos fiber Graphite	-
5	Packing gland follower	316 SS	-	13	Stem retention ring	316 SS	-
6	Stem packing	PTFE, Graphite	-	14	Bottom cover plate	Carbon steel 316 SS	ASTM A216-WCB ASTM A351-CF8M
7	Seat	Polymer Elastomer	PTFE, RTFE, UHMWPE NBR, EPDM, Fluoroelastomer (FKM)	15	Disc locating spacer	316 SS	-
8	Seat retainer ring gasket	Non-asbestos fiber, Graphite	Not used with Elastomer seats	16	Flange locator plate (wafer only)	Stainless steel Carbon steel/ zinc plated	-

Keystone High Performance Butterfly Valves

Series 36 and 37, 2" to 36"

Dimensions – Wafer Style

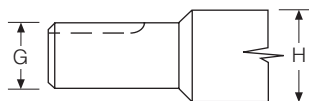

Upper Shaft/Keyway
8" to 24"

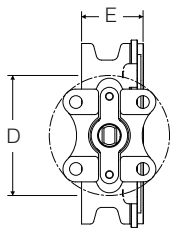

Top Plate View

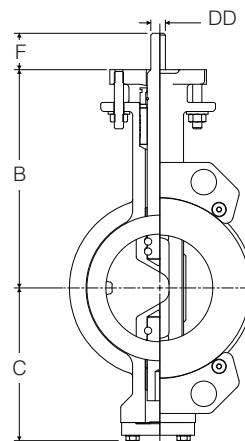
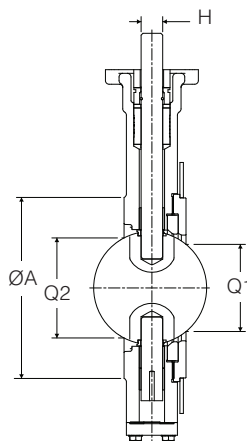

Series 36, ASME Class 150, Wafer Style, Dimensions in inches

Size	A	B	C	D	E	F	G	H	Q1	Q2	Top Plate Drilling			Hole Dia.	Wt. Lbs.	Act. Code
											DD or Keyway	Bolt Ø	No. Holes			
2	4 ¹⁵ / ₁₆	6	4	4	2 ³ / ₈	1 ¹ / ₄	N/A	9 ¹ / ₁₆	1 ³ / ₃₂	1 ¹¹ / ₁₆	3 ⁸ / ₁₆	3 ¹ / ₄	4	7 ¹ / ₁₆	9	BAB
2 ¹ / ₂	4 ¹ / ₈	6	4 ¹ / ₂	4	1 ⁷ / ₈	1 ¹ / ₄	N/A	9 ¹ / ₁₆	1 ³¹ / ₃₂	2 ³ / ₃₂	3 ⁸ / ₁₆	3 ¹ / ₄	4	7 ¹ / ₁₆	8	BAB
3	5	6 ⁵ / ₈	4 ⁷ / ₈	4	1 ⁷ / ₈	1 ¹ / ₄	N/A	5 ⁸ / ₁₆	1 ¹³ / ₁₆	2 ¹³ / ₃₂	7 ¹ / ₁₆	3 ¹ / ₄	4	7 ¹ / ₁₆	10	BAC
4	6 ³ / ₁₆	7 ¹ / ₂	5 ⁵ / ₁₆	4	2 ¹ / ₈	1 ¹ / ₄	N/A	3 ⁴ / ₁₆	3	3 ⁷ / ₃₂	1 ² / ₁₆	3 ¹ / ₄	4	7 ¹ / ₁₆	17	BAD
5	7 ⁵ / ₁₆	7 ⁹ / ₁₆	5 ¹³ / ₁₆	4	2 ¹ / ₄	1 ¹ / ₄	N/A	3 ⁸ / ₁₆	4 ¹ / ₄	4 ²¹ / ₃₂	1 ² / ₁₆	5	4	7 ¹ / ₁₆	20	BAD
6	8 ⁵ / ₁₆	8 ³ / ₄	7 ¹ / ₁₆	6	2 ¹ / ₄	1 ¹ / ₄	3 ⁴ / ₁₆	7 ⁸ / ₁₆	5 ³ / ₃₂	5 ³ / ₈	1 ² / ₁₆	5	4	9 ¹ / ₁₆	26	CAD
6*	8 ⁵ / ₁₆	8 ³ / ₄	7 ¹ / ₁₆	6	2 ¹ / ₄	1 ¹ / ₄	N/A	7 ⁸ / ₁₆	5 ³ / ₃₂	5 ³ / ₈	5 ⁸ / ₁₆	5	4	9 ¹ / ₁₆	26	CAE
8	10 ¹ / ₂	10 ¹ / ₈	8 ³ / ₈	6	2 ¹ / ₂	2	N/A	1 ¹ / ₈	6 ⁷ / ₈	7 ³ / ₁₆	1 ⁴ / ₄ x 1 ¹ / ₄ x 1 ⁵ / ₈	5	4	9 ¹ / ₁₆	45	CAF
10	12 ³ / ₄	11 ³ / ₈	9 ¹¹ / ₁₆	6	2 ¹³ / ₁₆	2	1 ¹ / ₈	1 ³ / ₈	8 ²⁹ / ₃₂	9 ⁵ / ₃₂	1 ⁴ / ₄ x 1 ¹ / ₄ x 1 ⁵ / ₈	5	4	9 ¹ / ₁₆	61	CAF
10*	12 ³ / ₄	11 ³ / ₈	9 ¹¹ / ₁₆	6	2 ¹³ / ₁₆	3	N/A	1 ³ / ₈	8 ²⁹ / ₃₂	9 ⁵ / ₃₂	5 ¹ / ₁₆ x 5 ¹ / ₁₆ x 2 ⁵ / ₈	6 ¹ / ₂	4	9 ¹ / ₁₆	61	CAG
12	15	13	11 ⁵ / ₁₆	8	3 ³ / ₁₆	3	1 ³ / ₈	1 ¹ / ₂	10 ³ / ₄	1 ¹¹ / ₁₆	5 ¹ / ₁₆ x 5 ¹ / ₁₆ x 2 ⁵ / ₈	6 ¹ / ₂	4	1 ³ / ₁₆	114	DAG
14	16 ¹ / ₄	13 ¹ / ₄	12 ¹¹ / ₁₆	8	3 ⁵ / ₈	3	N/A	1 ⁵ / ₈	11 ¹⁹ / ₃₂	12 ³ / ₃₂	3 ⁸ / ₈ x 3 ⁸ / ₈ x 2 ⁵ / ₈	6 ¹ / ₂	4	1 ³ / ₁₆	115	DAH
16	18 ¹ / ₂	14 ¹ / ₂	13 ⁷ / ₈	8	4	3	1 ⁵ / ₈	1 ³ / ₄	13 ⁵ / ₃₂	13 ²⁹ / ₃₂	3 ⁸ / ₈ x 3 ⁸ / ₈ x 2 ⁵ / ₈	6 ¹ / ₂	4	1 ³ / ₁₆	143	DAH
18	21	16	13 ³ / ₄	8	4 ¹ / ₂	4 ¹ / ₁₆	N/A	1 ⁷ / ₈	15 ⁹ / ₃₂	15 ³ / ₄	1 ² / ₂ x 3 ⁸ / ₈ x 4 ¹ / ₁₆	6 ¹ / ₂	4	1 ³ / ₁₆	243	DAJ
20	23	17 ⁷ / ₁₆	15 ³ / ₁₆	8	5	4 ⁵ / ₁₆	N/A	2 ¹ / ₄	17 ¹ / ₁₆	17 ¹⁵ / ₃₂	1 ² / ₂ x 3 ⁸ / ₈ x 4	6 ¹ / ₂	4	1 ³ / ₁₆	317	DAK
24	27 ¹ / ₄	19 ¹¹ / ₁₆	17 ⁹ / ₁₆	8	6 ¹ / ₁₆	4 ¹ / ₄	2 ¹ / ₄	2 ¹ / ₂	20 ³ / ₈	20 ¹³ / ₁₆	1 ² / ₂ x 3 ⁸ / ₈ x 4	6 ¹ / ₂	4	1 ³ / ₁₆	494	DAK
30	33 ³ / ₄	24 ¹ / ₂	20 ³ / ₄	9 ¹ / ₂	7 ³ / ₈	7	N/A	3	26 ¹⁷ / ₃₂	25 ¹⁷ / ₃₂	1 ² / ₂ x 3 ⁸ / ₈ x 4	9 ³ / ₄	4	1 ¹ / ₁₆	1136	MAZ
36	40 ¹ / ₄	28 ³ / ₈	23 ¹ / ₄	9 ¹ / ₂	8 ¹ / ₂	8	N/A	3 ¹ / ₂	32 ⁷ / ₈	32 ⁷ / ₈	7 ⁸ / ₈ x 7 ⁸ / ₈ x 5 ¹¹ / ₁₆	9 ³ / ₄	4	1 ¹ / ₁₆	1766	MBE

Note: * E.N.P. discs require larger upper stem connection diameters on 6 inch and 10 inch valve sizes for UHMWPE seat, metal seat and fire-safe seat trims.

Series 37, ASME Class 300, Wafer Style, Dimensions in inches

Size	A	B	C	D	E	F	G	H	Q1	Q2	Top Plate Drilling			Tapped Lug Data			Wt. Lbs.	Act. Code	
											DD or Keyway	Bolt Ø	Holes	No. Holes	Bolt Ø	Tap			
2	4 ⁵ / ₁₆	6	4	4	2 ³ / ₈	1 ¹ / ₄	N/A	9 ¹ / ₁₆	1 ³ / ₃₂	1 ¹¹ / ₁₆	3 ⁸ / ₁₆	3 ¹ / ₄	4	7 ¹ / ₁₆	-	-	-	10	BAB
2 ¹ / ₂	4 ¹ / ₈	6	4 ¹ / ₂	4	1 ⁷ / ₈	1 ¹ / ₄	N/A	9 ¹ / ₁₆	1 ³¹ / ₃₂	2 ³ / ₃₂	3 ⁸ / ₁₆	3 ¹ / ₄	4	7 ¹ / ₁₆	-	-	-	8	BAB
3	5	6 ⁵ / ₈	4 ⁷ / ₈	4	1 ⁷ / ₈	1 ¹ / ₄	N/A	5 ⁸ / ₁₆	1 ²⁹ / ₃₂	2 ¹¹ / ₃₂	7 ¹ / ₁₆	3 ¹ / ₄	4	7 ¹ / ₁₆	-	-	-	11	BAC
4	6 ³ / ₁₆	7 ¹ / ₂	5 ⁵ / ₁₆	4	2 ¹ / ₈	1 ¹ / ₄	N/A	3 ⁴ / ₁₆	3	3 ⁷ / ₃₂	1 ² / ₁₆	3 ¹ / ₄	4	7 ¹ / ₁₆	-	-	-	16	BAD
5	7 ⁵ / ₁₆	7 ⁹ / ₁₆	5 ¹³ / ₁₆	4	2 ⁵ / ₁₆	1 ¹ / ₄	N/A	3 ⁴ / ₁₆	5 ³ / ₃₂	4 ⁵ / ₈	1 ² / ₁₆	3 ¹ / ₄	4	7 ¹ / ₁₆	-	-	-	22	BAD
6	8 ¹ / ₂	8 ³ / ₄	7 ¹ / ₁₆	6	2 ⁵ / ₁₆	1 ¹ / ₄	N/A	7 ⁸ / ₁₆	5 ¹ / ₃₂	5 ³ / ₈	5 ⁸ / ₁₆	5	4	9 ¹ / ₁₆	-	-	-	28	CAE
8	10 ⁵ / ₈	10 ¹ / ₈	8 ³ / ₈	6	2 ⁷ / ₈	2	N/A	1 ¹ / ₈	6 ¹⁷ / ₃₂	7 ³ / ₁₆	1 ⁴ / ₄ x 1 ¹ / ₄ x 1 ⁵ / ₈	5	4	9 ¹ / ₁₆	-	-	-	54	CAF
10	12 ³ / ₄	11 ³ / ₈	9 ¹¹ / ₁₆	6	3 ¹ / ₄	3	N/A	1 ³ / ₈	8 ⁵ / ₈	9 ⁵ / ₃₂	5 ¹ / ₁₆ x 5 ¹ / ₁₆ x 2 ⁵ / ₈	5	4	9 ¹ / ₁₆	4	15 ¹ / ₄	1-8UN	90	CAG
12	15	13	11 ⁵ / ₁₆	8	3 ⁵ / ₈	3	1 ³ / ₈	1 ¹ / ₂	10 ⁷ / ₃₂	11 ¹ / ₁₆	5 ¹ / ₁₆ x 5 ¹ / ₁₆ x 2 ⁵ / ₈	6 ¹ / ₂	4	1 ³ / ₁₆	-	-	-	124	DAG
14	16 ¹ / ₄	14 ³ / ₈	12 ¹¹ / ₁₆	8	4 ⁵ / ₈	4 ¹ / ₄	N/A	1 ⁷ / ₈	11 ¹⁵ / ₃₂	11 ⁵ / ₈	1 ² / ₂ x 3 ⁸ / ₈ x 4 ¹ / ₈	6 ¹ / ₂	4	1 ³ / ₁₆	4	20 ¹ / ₄	11/8-8UN	197	DAJ
16	18 ¹ / ₂	16 ¹ / ₁₆	13 ⁷ / ₈	8	5 ¹ / ₄	4 ¹ / ₈	N/A	2 ¹ / ₄	13 ³ / ₁₆	13 ⁵ / ₁₆	1 ² / ₂ x 3 ⁸ / ₈ x 4	6 ¹ / ₂	4	1 ³ / ₁₆	4	22 ¹ / ₂	11/4-8UN	265	DAK
18	21	17	15 ¹ / ₁₆	8	5 ⁷ / ₈	4 ⁷ / ₃₂	N/A	2 ¹ / ₂	15 ³ / ₃₂	15 ³ / ₁₆	5 ⁸ / ₈ x 5 ⁸ / ₈ x 4	6 ¹ / ₂	4	1 ³ / ₁₆	4	24 ³ / ₄	11/4-8UN	365	DBA
20	23	20 ³ / ₁₆	16 ³ / ₈	7 ¹ / ₂	6 ¹ / ₄	6 ¹ / ₂	N/A	2 ³ / ₄	16 ²⁷ / ₃₂	17	5 ⁸ / ₈ x 5 ⁸ / ₈ x 5 ³ / ₈	8	4	1 ³ / ₁₆	4	27	11/4-8UN	478	LAX
24	27 ¹ / ₄	23 ³ / ₈	19 ¹ / ₈	9 ¹ / ₂	7 ¹ / ₈	6 ¹³ / ₁₆	N/A	3 ¹ / ₂	20 ¹ / ₄	20 ³ / ₈	7 ⁸ / ₈ x 7 ⁸ / ₈ x 5 ¹¹ / ₁₆	9 ³ / ₄	4	1 ¹ / ₁₆	4	32	11/2-8UN	789	MAY

Keystone High Performance Butterfly Valves

Series 36 and 37, 2" to 36"

Dimensions – Lug Style

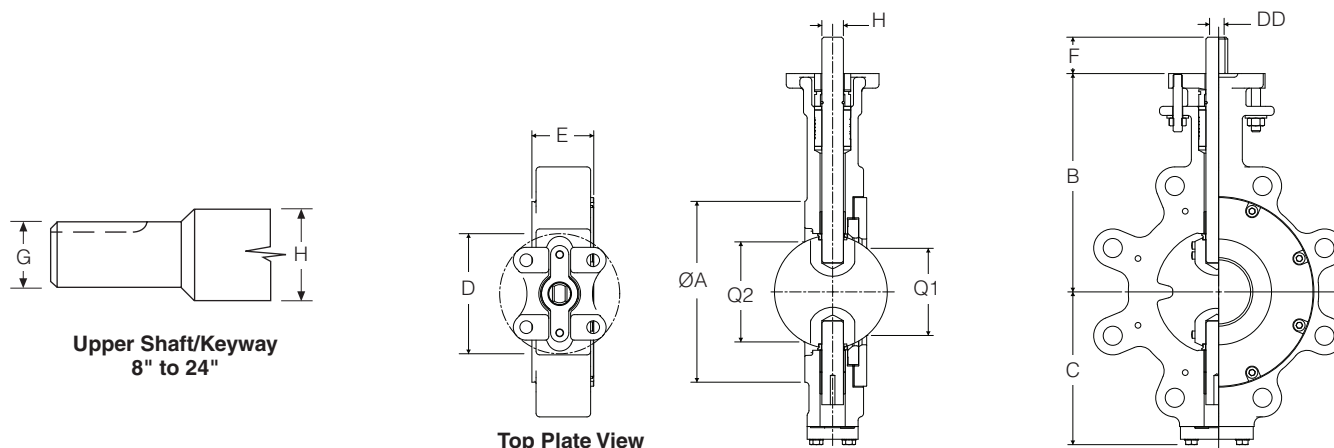

Upper Shaft/Keyway
8" to 24"

Top Plate View

Series 36, ASME Class 150, Lug Style, Dimensions in inches

Size	A	B	C	D	E	F	G	H	Q1	Q2	Top Plate Drilling			Tapped Lug Data			Wt. Lbs.	Act. Code	
											DD or Keyway	Bolt Ø	Holes No. Dia.	No. Holes	Bolt Ø	Tap			
2	4 ¹⁵ / ₃₂	6	3 ¹³ / ₁₆	4	2 ³ / ₈	1 ¹ / ₄	N/A	9/16	1 ³ / ₃₂	1 ¹¹ / ₁₆	3/8	3 ¹ / ₄	4	7/16	4	4 ³ / ₄	5/8-11UNC	12	BAB
2 1/2	4 ¹³ / ₁₆	6	4 ³ / ₁₆	4	1 ⁷ / ₈	1 ¹ / ₄	N/A	9/16	1 ³¹ / ₃₂	2 ³ / ₃₂	3/8	3 ¹ / ₄	4	7/16	4	5 ¹ / ₂	5/8-11UNC	12	BAB
3	5 ⁵ / ₁₆	6 ⁵ / ₈	4 ¹³ / ₁₆	4	1 ⁷ / ₈	1 ¹ / ₄	N/A	5/8	1 ¹³ / ₁₆	2 ¹³ / ₃₂	7/16	3 ¹ / ₄	4	7/16	4	6	5/8-11UNC	15	BAC
4	6 ¹⁵ / ₃₂	7 ¹ / ₂	5 ¹ / ₁₆	4	2 ¹ / ₈	1 ¹ / ₄	N/A	3/4	3	3 ⁷ / ₁₆	1/2	3 ¹ / ₄	4	7/16	8	7 ¹ / ₂	5/8-11UNC	22	BAD
5	7 ¹⁹ / ₃₂	7 ⁹ / ₁₆	5 ⁹ / ₁₆	4	2 ¹ / ₄	1 ¹ / ₄	N/A	3/4	4 ¹ / ₄	4 ²¹ / ₃₂	1/2	3 ¹ / ₄	4	7/16	8	8 ¹ / ₂	3/4-10UNC	29	BAD
6	8 ⁷ / ₈	8 ³ / ₄	5 ¹¹ / ₁₆	6	2 ¹ / ₄	1 ¹ / ₄	3/4	7/8	5 ³ / ₃₂	5 ³ / ₈	1/2	5	4	9/16	8	9 ¹ / ₂	3/4-10UNC	38	CAD
6*	8 ⁷ / ₈	8 ³ / ₄	5 ¹¹ / ₁₆	6	2 ¹ / ₄	1 ¹ / ₄	N/A	7/8	5 ³ / ₃₂	5 ³ / ₈	5/8	5	4	9/16	8	9 ¹ / ₂	3/4-10UNC	38	CAE
8	10 ⁵ / ₈	10 ¹ / ₈	8 ¹ / ₁₆	6	2 ¹ / ₂	2	N/A	1 ¹ / ₈	6 ⁷ / ₈	7 ³ / ₁₆	1/4 x 1/4 x 15/8	5	4	9/16	8	11 ³ / ₄	3/4-10UNC	58	CAF
10	12 ³ / ₄	11 ³ / ₈	9 ³ / ₈	6	2 ¹³ / ₁₆	2	1 ¹ / ₈	1 ³ / ₈	8 ²⁹ / ₃₂	9 ⁵ / ₃₂	1/4 x 1/4 x 15/8	5	4	9/16	12	14 ¹ / ₄	7/8-9UNC	86	CAF
10*	12 ³ / ₄	11 ³ / ₈	9 ³ / ₈	6	2 ¹³ / ₁₆	3	N/A	1 ³ / ₈	8 ²⁹ / ₃₂	9 ⁵ / ₃₂	5/16 x 5/16 x 25/8	5	4	9/16	12	14 ¹ / ₄	7/8-9UNC	86	CAG
12	15	13	10 ⁵ / ₁₆	8	3 ³ / ₁₆	3	1 ³ / ₈	1 ¹ / ₂	10 ³ / ₄	1 ¹¹ / ₁₆	5/16 x 5/16 x 25/8	6 ¹ / ₂	4	13/16	12	17	7/8-9UNC	144	DAG
14	16 ¹ / ₄	13 ¹ / ₄	11 ⁹ / ₁₆	8	3 ⁵ / ₈	3	N/A	1 ⁵ / ₈	11 ¹⁹ / ₃₂	12 ³ / ₃₂	3/8 x 3/8 x 25/8	6 ¹ / ₂	4	13/16	12	18 ³ / ₄	1-8UN	154	DAH
16	18 ¹ / ₂	14 ¹ / ₂	12 ¹¹ / ₁₆	8	4	3	1 ⁵ / ₈	1 ³ / ₄	13 ⁵ / ₃₂	13 ²⁹ / ₃₂	3/8 x 3/8 x 25/8	6 ¹ / ₂	4	13/16	16	21 ¹ / ₄	1-8UN	210	DAH
18	21	16	13 ³ / ₈	8	4 ¹ / ₂	4 ¹ / ₁₆	N/A	1 ⁷ / ₈	15 ⁹ / ₃₂	15 ³ / ₄	1/2 x 3/8 x 4 ¹ / ₁₆	6 ¹ / ₂	4	13/16	16	22 ³ / ₄	1 ¹ / ₈ -8UN	308	DAJ
20	23	17 ⁷ / ₁₆	14 ¹³ / ₁₆	8	5	4 ⁵ / ₁₆	N/A	2 ¹ / ₄	17 ¹ / ₁₆	17 ¹⁵ / ₃₂	1/2 x 3/8 x 4	6 ¹ / ₂	4	13/16	20	25	1 ¹ / ₈ -8UN	403	DAK
24	27 ¹ / ₄	19 ¹¹ / ₁₆	17 ³ / ₁₆	8	6 ¹ / ₁₆	4 ¹ / ₄	2 ¹ / ₄	2 ¹ / ₂	20 ³ / ₈	20 ¹³ / ₁₆	1/2 x 3/8 x 4	6 ¹ / ₂	4	13/16	20	29 ¹ / ₂	1 ¹ / ₄ -8UN	612	DAK
30	33 ³ / ₄	24 ¹ / ₂	20 ³ / ₈	9 ¹ / ₂	7 ³ / ₈	7	N/A	3	26 ¹⁷ / ₃₂	25 ¹⁷ / ₃₂	3/4 x 3/4 x 6	9 ³ / ₄	4	11/16	28	36	1 ¹ / ₄ -8UN	1120	MAZ
36	40 ¹ / ₄	28 ³ / ₈	23 ⁷ / ₈	9 ¹ / ₂	8 ¹ / ₂	8	N/A	3 ¹ / ₂	32 ⁷ / ₈	32 ⁷ / ₈	7/8 x 7/8 x 5 ¹¹ / ₁₆	9 ³ / ₄	4	11/16	32	42 ³ / ₄	1 ¹ / ₂ -8UN	1879	MBE

Note: * E.N.P. discs require larger upper stem connection diameters on 6 inch and 10 inch valve sizes for UHMWPE seat, metal seat and fire-safe seat trims.

Series 37, ASME Class 300, Lug Style, Dimensions in inches

Size	A	B	C	D	E	F	G	H	Q1	Q2	Top Plate Drilling			Tapped Lug Data			Wt. Lbs.	Act. Code		
											DD or Keyway	Bolt Ø	Holes No. Dia.	No. Holes	Bolt Ø	Tap				
2	4 ¹⁵ / ₃₂	6	3 ¹³ / ₁₆	4	2 ³ / ₈	1 ¹ / ₄	N/A	9/16	1 ³ / ₃₂	1 ¹¹ / ₁₆	3/8	3 ¹ / ₄	4	7/16	8	5	3/4-10UNC	13	BAB	
2 1/2	4 ¹³ / ₁₆	6	4 ³ / ₁₆	4	1 ⁷ / ₈	1 ¹ / ₄	N/A	9/16	1 ³¹ / ₃₂	2 ³ / ₃₂	3/8	3 ¹ / ₄	4	7/16	8	5 ⁷ / ₈	3/4-10UNC	15	BAB	
3	5 ⁵ / ₁₆	6 ⁵ / ₈	4 ¹ / ₂	4	1 ⁷ / ₈	1 ¹ / ₄	N/A	5/8	1 ²⁹ / ₃₂	2 ¹¹ / ₃₂	7/16	3 ¹ / ₄	4	7/16	8	6 ⁵ / ₈	3/4-10UNC	17	BAC	
4	6 ¹⁵ / ₃₂	7 ¹ / ₂	5 ¹ / ₁₆	4	2 ¹ / ₈	1 ¹ / ₄	N/A	3/4	3	3 ⁷ / ₁₆	1/2	3 ¹ / ₄	4	7/16	8	7 ⁷ / ₈	3/4-10UNC	25	BAD	
5	7 ⁵ / ₈	7 ⁹ / ₁₆	5 ⁹ / ₁₆	4	2 ⁵ / ₁₆	1 ¹ / ₄	N/A	3/4	4 ⁵ / ₃₂	4 ⁵ / ₈	1/2	3 ¹ / ₄	4	7/16	8	9 ¹ / ₄	3/4-10UNC	33	BAD	
6	8 ⁷ / ₈	8 ³ / ₄	6 ¹¹ / ₁₆	6	2 ⁵ / ₁₆	1 ¹ / ₄	N/A	7/8	5 ¹ / ₃₂	5 ³ / ₈	5/8	5	4	9/16	12	10 ⁵ / ₈	3/4-10UNC	43	CAE	
8	11 ⁵ / ₃₂	10 ¹ / ₈	8 ¹ / ₁₆	6	2 ⁷ / ₈	2	N/A	1 ¹ / ₈	6 ¹⁷ / ₃₂	7 ³ / ₁₆	1/4 x 1/4 x 15/8	5	4	9/16	12	13	7/8-9UNC	78	CAF	
10	12 ³ / ₄	11 ³ / ₈	9 ³ / ₈	6	3 ¹ / ₄	3	N/A	1 ³ / ₈	8 ⁵ / ₈	9 ⁵ / ₃₂	5/16 x 5/16 x 25/8	5	4	9/16	16	15 ¹ / ₄	1-8UN	117	CAG	
12	15	13	10 ¹³ / ₁₆	8	3 ⁵ / ₈	3	1 ³ / ₈	1 ¹ / ₂	10 ⁷ / ₁₆	1 ¹¹ / ₁₆	5/16 x 5/16 x 25/8	6 ¹ / ₂	4	13/16	16	17 ³ / ₄	1 ¹ / ₈ -8UN	177	DAG	
14	16 ¹ / ₄	14 ³ / ₈	12 ⁵ / ₁₆	8	4 ⁵ / ₈	4 ¹ / ₄	N/A	1 ⁷ / ₈	11 ¹⁵ / ₃₂	1 ¹¹ / ₈	1/2 x 3/8 x 4 ¹ / ₁₆	6 ¹ / ₂	4	13/16	20	20 ¹ / ₄	1 ¹ / ₈ -8UN	277	DAJ	
16	18 ¹ / ₂	16 ¹ / ₁₆	13 ¹ / ₂	8	5 ¹ / ₄	4	1/8	N/A	2 ¹ / ₄	13 ³ / ₁₆	13 ⁵ / ₁₆	1/2 x 3/8 x 4	6 ¹ / ₂	4	13/16	20	22 ¹ / ₂	1 ¹ / ₄ -8UN	366	DAK
18	21	17	14 ¹¹ / ₁₆	8	5 ⁷ / ₈	4 ⁷ / ₃₂	N/A	2 ¹ / ₂	15 ³ / ₃₂	15 ³ / ₁₆	5/8 x 5/8 x 4	6 ¹ / ₂	4	13/16	24	24 ³ / ₄	1 ¹ / ₄ -8UN	485	DBA	
20	23	20 ³ / ₁₆	16	7 ¹ / ₂	6 ¹ / ₄	6 ¹ / ₂	N/A	2 ³ / ₄	16 ²⁷ / ₃₂	17	5/8 x 5/8 x 6 ³ / ₈	8	4	13/16	24	27	1 ¹ / ₄ -8UN	617	LAX	
24	27 ¹ / ₄	23 ³ / ₈	18 ³ / ₄	9 ¹ / ₂	7 ¹ / ₈	6 ¹³ / ₁₆	N/A	3 ¹ / ₂	20 ¹ / ₄	20 ³ / ₈	7/8 x 7/8 x 5 ¹¹ / ₁₆	9 ³ / ₄	4	11/16	24	32	1 ¹ / ₂ -8UN	1011	MAY	

Keystone High Performance Butterfly Valves

Series 36 and 37, 2" to 36"

Recommended Flange Bolt Lengths

Series 36, Wafer Style, 150 Class

Valve Size (inch)	Qty	Type 1 (Flange Bolt) (HEX Head)	Qty	Type 2 (Threaded Rod) (All Thread)
2	4	5/8 - 11UNC x 5	4	5/8 - 11UNC x 5 3/4
2 1/2	4	5/8 - 11UNC x 4 5/8	4	5/8 - 11UNC x 5 5/8
3	4	5/8 - 11UNC x 5	4	5/8 - 11UNC x 5 5/8
4	8	5/8 - 11UNC x 5	8	5/8 - 11UNC x 5 7/8
5	8	3/4 - 10UNC x 5 1/4	8	3/4 - 10UNC x 6 1/4
6	8	3/4 - 10UNC x 5 3/8	8	3/4 - 10UNC x 6 3/8
8	8	3/4 - 10UNC x 5 7/8	8	3/4 - 10UNC x 6 7/8
10	12	7/8 - 9UNC x 6 1/2	12	7/8 - 9UNC x 7 5/8
12	12	7/8 - 9UNC x 7	12	7/8 - 9UNC x 8
14	12	1 - 8UN x 7 3/4	12	1 - 8UN x 9
16	16	1 - 8UN x 8 1/2	16	1 - 8UN x 9 5/8
18	16	1 1/8 - 8UN x 9 1/2	16	1 1/8 - 8UN x 10 5/8
20	16	1 1/8 - 8UN x 10	16	1 1/8 - 8UN x 11 3/8
	4	1 1/8 - 8UN x 3 1/2	8	1 1/8 - 8UN x 4 7/8
	4	1 1/8 - 8UN x 3 1/4		
24	16	1 1/4 - 8UN x 11 1/2	16	1 1/4 - 8UN x 13
	8	1 1/4 - 8UN x 4 3/4	8	1 1/4 - 8UN x 6 3/8
30	24	1 1/4 - 8UN x 14 7/8	24	1 1/4 - 8UN x 16 3/8
	8	1 1/4 - 8UN x 4 3/4	8	1 1/4 - 8UN x 6 1/4
36	28	1 1/2 - 8UN x 17 1/2	28	1 1/2 - 8UN x 19 1/4
	8	1 1/2 - 8UN x 7 1/2	8	1 1/2 - 8UN x 9 1/4

Type 1

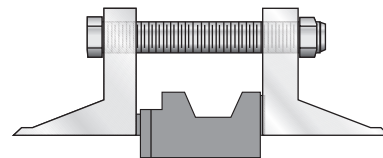

Type 2

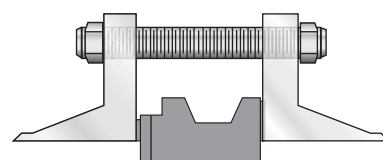

Series 37, Wafer Style, 300 Class

Valve Size (inch)	Qty	Type 1 (Flange Bolt) (HEX Head)	Qty	Type 2 (Threaded Rod) (All Thread)
2	8	5/8 - UNC x 5 1/4	8	5/8 - 11UNC x 6 1/4
2 1/2	8	3/4 - 10UNC x 5	8	3/4 - 10UNC x 6
3	8	3/4 - 10UNC x 5 1/4	8	3/4 - 10UNC x 6 1/4
4	8	3/4 - 11UNC x 5 3/4	8	3/4 - 11UNC x 6 3/4
5	8	3/4 - 11UNC x 6 1/4	8	3/4 - 11UNC x 7 1/4
6	12	3/4 - 11UNC x 6 3/8	12	3/4 - 11UNC x 7 3/8
8	12	7/8 - 10UNC x 7 1/2	12	7/8 - 10UNC x 8 1/2
10	12	1 - 8UN x 8 1/2	12	1 - 8UN x 9 1/2
	8	1 - 8UN x 3	8	1 - 8UN x 4 3/4
12	16	1 1/8 - 8UN x 9 1/4	16	1 1/8 - 8UN x 10 1/2
14	16	1 1/8 - 8UN x 10 1/2	16	1 1/8 - 8UN x 11 3/4
	8	1 1/8 - 8UN x 3 1/4	8	1 1/8 - 8UN x 4 5/8
16	16	1 1/4 - 8UN x 11 1/2	16	1 1/4 - 8UN x 12 5/8
	8	1 1/4 - 8UN x 3 1/2	8	1 1/4 - 8UN x 5
18	20	1 1/4 - 8UN x 12 1/4	20	1 1/4 - 8UN x 13 3/4
	8	1 1/4 - 8UN x 3 3/4	8	1 1/4 - 8UN x 5 1/4
20	20	1 1/4 - 8UN x 12 7/8	20	1 1/4 - 8UN x 14 5/16
	8	1 1/4 - 8UN x 4	8	1 1/4 - 8UN x 5 1/2
24	20	1 1/2 - 8UN x 14 1/2	20	1 1/2 - 8UN x 16 1/4
	8	1 1/2 - 8UN x 4 1/2	8	1 1/2 - 8UN x 6 1/4

Recommended Flange Bolt Lengths

Type 3

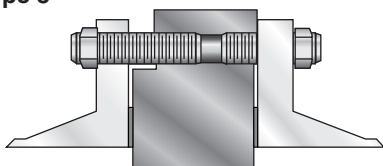

Type 4

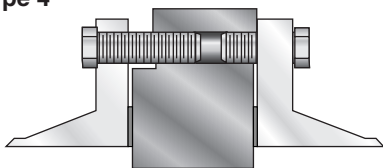

Series 36, Lug Style, 150 Class

Valve Size (inch)	Qty	Type 3 (Threaded Studs) (Full Thread)	Qty	Type 4 (Flange Bolt) (HEX Head)
2	8	5/8 - 11UNC x 27/8	8	5/8 - 11UNC x 2
2 1/2	8	5/8 - 11UNC x 2 5/8	8	5/8 - 11UNC x 1 3/4
3	8	5/8 - 11UNC x 2 5/8	8	5/8 - 11UNC x 1 3/4
4	16	5/8 - 11UNC x 2 3/4	16	5/8 - 11UNC x 2
5	16	3/4 - 10UNC x 3	16	3/4 - 10UNC x 2
6	8	3/4 - 10UNC x 3	8	3/4 - 10UNC x 2
6	8	3/4 - 10UNC x 3 1/4	8	3/4 - 10UNC x 2 1/4
8	16	3/4 - 10UNC x 3 3/8	16	3/4 - 10UNC x 2 1/4
10	24	7/8 - 9UNC x 3 5/8	24	7/8 - 9UNC x 2 1/2
12	24	7/8 - 9UNC x 3 7/8	24	7/8 - 9UNC x 2 3/4
14	24	1 - 9UNC x 4 1/2	24	1 - 9UNC x 3 1/4
16	32	1 - 8UN x 4 3/4	32	1 - 8UN x 3 1/2
18	32	1 1/8 - 8UN x 5 1/4	32	1 1/8 - 8UN x 3 3/4
20	32	1 1/8 - 8UN x 5 1/2	4	1 1/8 - 8UN x 3 1/2 (FF)
	8	1 1/8 - 8UN x 4 7/8	4	1 1/8 - 8UN x 3 1/4 (BF)
			32	1 1/8 - 8UN x 4
24	40	1 1/4 - 8UN x 6 3/8	40	1 1/4 - 8UN x 4 3/4
30	48	1 1/4 - 8UN x 8	48	1 1/4 - 8UN x 6 1/2
	8	1 1/4 - 8UN x 6 1/4	8	1 1/4 - 8UN x 4 3/4
36	56	1 1/2 - 8UN x 9 1/4	56	1 1/2 - 8UN x 7 1/2
	8	1 1/2 - 8UN x 7 1/2	8	1 1/2 - 8UN x 5 3/4

Series 37, Lug Style, 300 Class

Valve Size (inch)	Qty	Type 3 (Threaded Studs) (All Thread)	Qty	Type 4 (Flange Bolt) (HEX Head)
2	16	5/8 - 11UNC x 27/8	16	5/8 - 11UNC x 2
2 1/2	16	3/4 - 10UNC x 3	16	3/4 - 10UNC x 2
3	16	3/4 - 10UNC x 3	16	3/4 - 10UNC x 2
4	16	3/4 - 10UNC x 3 1/4	16	3/4 - 10UNC x 2 1/4
5	16	3/4 - 10UNC x 3 1/2	16	3/4 - 10UNC x 2 1/2
6	24	3/4 - 10UNC x 3 5/8	24	3/4 - 10UNC x 2 1/2
8	24	7/8 - 9UNC x 4 1/8	24	7/8 - 9UNC x 3
10	32	1 - 9UNC x 4 3/4	32	1 - 9UNC x 3 1/2
12	32	1 1/8 - 8UN x 5 1/8	32	1 1/8 - 8UN x 3 3/4
14	32	1 1/8 - 8UN x 5 3/4	32	1 1/8 - 8UN x 4 1/4
	8	1 1/8 - 8UN x 4 5/8	8	1 1/8 - 8UN x 3 1/4
16	32	1 1/4 - 8UN x 6 1/4	32	1 1/4 - 8UN x 4 3/4
	8	1 1/4 - 8UN x 5	8	1 1/4 - 8UN x 3 1/2
18	40	1 1/4 - 8UN x 6 3/4	40	1 1/4 - 8UN x 5 1/4
	8	1 1/4 - 8UN x 5 1/4	8	1 1/4 - 8UN x 3 3/4
20	40	1 1/4 - 8UN x 7 1/8	40	1 1/4 - 8UN x 5 1/2
	8	1 1/4 - 8UN x 5 1/2	8	1 1/4 - 8UN x 4
24	40	1 1/2 - 8UN x 8	40	1 1/2 - 8UN x 6 1/4
	8	1 1/2 - 8UN x 6 1/4	8	1 1/2 - 8UN x 4 1/2

Keystone High Performance Butterfly Valves

Series 36 and 37, 2" to 36"

Extension Brackets For Various Temperatures

Pipeline Fluid Temperature	Required Extension Lengths (inches)				
	Handle	Gear	200°F Std. F79U	450°F High Temp. F79U	Standard F777
-100°F to 375°F	–	–	–	–	–
376°F to 460°F	4	–	–	–	4
461°F to 560°F	6	4	4	–	4
561°F to 650°F	6	4	4	–	4
651°F to 725°F	6	6	6	4	6
726°F to 825°F	8	8	8	6	8
826°F to 925°F	10	8	8	6	8
926°F to 1000°F	10	10	10	8	10

Notes:

1. Surrounding air temperature is assumed to be 70°F. For every degree over 100°F of the surrounding air, deduct 2 degrees from the maximum temperature ranges shown under the Pipeline Fluid Temperature Column. (Example: 125°F external temperature reduces maximum temperature values under the Pipeline Fluid Temperature Column to 325, 410, 510, 600, etc.)
2. Valves may be insulated or uninsulated.
3. Brackets may be open rectangular tubes or the standard closed Keystone tubular stem extensions.
4. All actuators have a maximum service temperature (outside atmosphere). These temperature limitations apply regardless of K-LOK® extension lengths.

Vacuum Rating

The combination of interference fit seats and bi-directional packing makes the K-LOK® especially well suited for vacuum service.

Standard K-LOK® high performance valves are rated to an absolute pressure of 4×10^{-5} inch Hg. Higher vacuum applications are available.

Pressure/Temperature Ratings for Seat Materials

Elastomer Seats

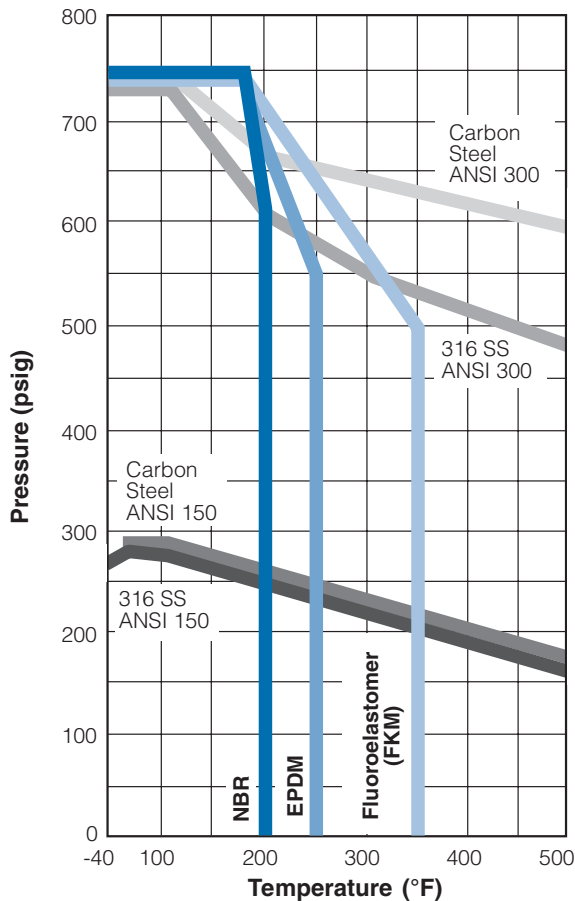

Polymer Seats

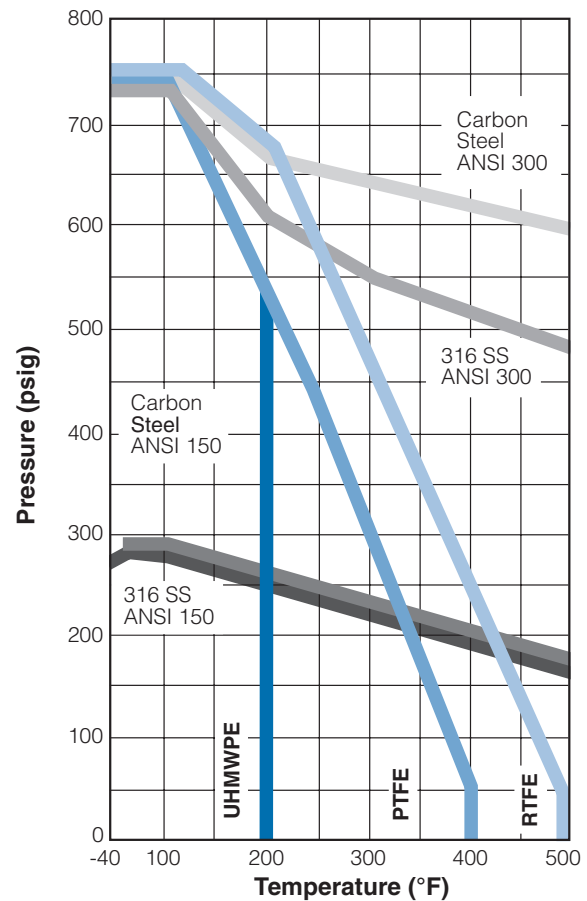

Seating and Un-seating Torque

Seating and un-seating torques are a function of the size of the valve and the shutoff pressure of the system.

Specific torque ratings can be found in the Seating/Un-seating chart at the intersection of the "size" row and the "shutoff pressure" column.

Torques listed are for PTFE and RTFE seated valves. For different seat materials, specific multipliers are to be used as stated.

All torques listed are for normal service conditions (i.e. operating frequency is a minimum of once per month; disc corrosion is expected to be mild or minor, the media is a clean gas, liquid or steam, and is non-abrasive) and chemical effects upon the seat are minor.

PTFE and RTFE Bi-Directional Seating and Un-Seating Torque Values

Valve Size (inch)	Shaft Mounting Code (ANSI)		Seating and Un-seating Torque (lbs. in.) System Shutoff Pressure (psig)						
	150	300	150	200	285	400	500	740	
2	BAB	BAB	220	280	380	460	520	580	
2 1/2	BAB	BAB	220	280	380	460	520	580	
3	BAC	BAC	250	320	430	520	590	650	
4	BAD	BAD	475	600	820	995	1,120	1,235	
5	BAD	BAD	925	1,125	1,350	1,570	1,750	1,900	
6	CAD/CAE*	CAE	1,370	1,600	1,850	2,150	2,390	2,900	
8	CAF	CAF	2,060	2,330	3,200	4,020	4,870	6,720	
10	CAF/CAG*	CAG	3,340	3,650	4,700	6,250	7,450	9,850	
12	DAG	DAG	4,590	5,250	6,400	8,160	9,690	12,940	
14	DAH	DAJ	6,750	7,560	9,150	11,450	13,300	17,200	
16	DAH	DAK	9,350	10,450	12,600	15,000	17,500	22,200	
18	DAJ	DBA	11,900	13,300	15,800	19,500	21,900	28,500	
20	DAK	LAX	15,600	17,500	21,000	25,200	28,700	36,140	
24	DAK	MAY	21,700	25,340	30,600	36,900	42,100	54,000	
30	MAZ	NAW	29,200	35,000	43,500	—	—	—	
36	MBE	EBD	52,500	58,500	70,000	—	—	—	

*CAE and CAG mounting codes apply for shaft mounting of UHMWPE, metal and fire-safe seats.

Notes:

- Torques are applicable only to PTFE and RTFE seats in noncorrosive or non-abrasive services such as water.
- For other seat materials, select the torque applicable for the maximum differential pressure and multiply by the following factor:
 EPDM/NBR/Fluoroelastomer (FKM): x 1.4
 UHMWPE (Clean Service): x 1.3
- For corrosive, abrasive or other services than water, multiply by the following factor:
 High solids slurry: x 1.5
 Dry gas: x 2.0
 Dry powders: x 2.7
 Liquids other than water: x 1.2
 Lubricating fluids: x 0.8
 For services that combine unfriendly conditions such as extreme temperatures and high solids, or corrosive with high temperatures, contact your sales representative.

Cv Values vs. Travel Position

Size (in.)	Angle of Opening								CL 150 90°	CL 300 90°
	10°	20°	30°	40°	50°	60°	70°	80°		
2	6	10	19	34	51	78	105	134	163	160
2 1/2	6	10	19	34	53	80	111	148	175	170
3	8	12	24	43	67	100	139	186	220	215
4	16	23	44	80	130	194	269	360	425	413
5	30	44	83	149	242	366	504	673	795	785
6	50	70	130	230	370	550	760	1,010	1,195	1,140
8	83	117	251	437	695	1,052	1,496	2,001	2,440	2,300
10	144	202	454	754	1,185	1,821	2,611	3,541	4,540	4,333
12	208	304	678	1,051	1,625	2,766	3,838	5,325	6,915	6,600
14	257	360	747	1,186	1,909	3,121	4,416	6,225	8,300	7,920
16	308	432	803	1,422	2,289	3,614	5,251	7,530	10,040	9,580
18	373	548	1,121	1,869	2,990	4,735	6,728	9,845	12,460	11,890
20	463	680	1,390	2,315	4,010	6,175	8,795	12,655	15,430	14,720
24	650	991	2,076	3,803	6,060	9,091	13,301	18,466	21,660	20,665
30	1,015	1,550	3,240	4,670	9,460	14,200	21,400	29,800	36,000	—
36	1,460	2,300	4,640	5,950	13,700	21,000	30,400	44,000	56,000	—

Keystone High Performance Butterfly Valves

Series 36 and 37, 2" to 36"

Ordering Information

Example:

4" 150 ASME Lug Style Carbon Steel Body,
SS disc, 17-4SS Stem, RTFE Seat, Bare Shaft,
NACE **040 362 CSS1TSG 0 N**

040 36 2 C S S 1 T S G O N

Size

020	040	080	140	200	360
025	050	100	160	240	
030	060	120	180	300	

Series

36 – 150 ASME
37 – 300 ASME

Body Style

0 – Wafer
2 – Lug²

Body Material

C – Carbon Steel **D** – Duplex 2205
S – Stainless Steel **X** – Other

Disc Material

S – 316 Stainless Steel **D** – Duplex 2205
E – 316/SS ENP **X** – Other

Stem

S – 17-4 PH **M** – K-500 Monel® **D** – Duplex 2205
P – 316B - SS (Optional)⁴ **N** – NITRONIC® 50 **X** – Other

Seat/Back Ring Material

1 – RTFE/SS	6 – UMPHWE ¹	9 – Viton®
2 – RTFE/Plastic	7 – NBR	X – Other
3 – PTFE/SS	8 – EPDM	

Packing Material

T – Teflon®
G – Graphite

Bearings

S – SS-Nitrided **X** – Other
R – RTFE/Epoxy

Body Gaskets³

G – Graphite (Standard)
F – Fiber (Optional)

Actuation

0 – None	2 – Gear	4 – Pneumatic DA	6 – Electric
1 – 10 pos handle	3 – Chainwheel	5 – Pneumatic SR	X – Other

Special

N – NACE	C – Oxygen Clean	W – NSF/ANSI Standard 61 tagging	X – Other
L – Chlorine Cleaning	P – PED/CE	G – Grease Fittings	

Notes:

1. UMPHWE seats must use ENP coated disc.
2. All lug valves are drilled for full rated bi-directional dead end service.
3. Standard body gasket is graphite. Fiber is provided for special applications.
4. Standard stem material is 17-4PH-SS. 316 SS is provided for special applications.

www.keystonevalves.com

Tyco Flow Control (TFC) provides the information herein in good faith but makes no representation as to its comprehensiveness or accuracy. This data sheet is intended only as a guide to TFC products and services. Individuals using this data sheet must exercise their independent judgment in evaluating product selection and determining product appropriateness for their particular purpose and system requirements. TFC MAKES NO REPRESENTATIONS OR WARRANTIES, EITHER EXPRESS OR IMPLIED, INCLUDING WITHOUT LIMITATION ANY WARRANTIES OF MERCHANTABILITY OR FITNESS FOR A PARTICULAR PURPOSE WITH RESPECT TO THE INFORMATION SET FORTH HEREIN OR THE PRODUCT(S) TO WHICH THE INFORMATION REFERS. ACCORDINGLY, TFC WILL NOT BE RESPONSIBLE FOR DAMAGES (OF ANY KIND OR NATURE, INCLUDING INCIDENTAL, DIRECT, INDIRECT, OR CONSEQUENTIAL DAMAGES) RESULTING FROM THE USE OF OR RELIANCE UPON THIS INFORMATION. Patents and Patents Pending in the U.S. and foreign countries. Tyco reserves the right to change product designs and specifications without notice. All registered trademarks are the property of their respective owners. Printed in the USA.